

# DOMEA









# DOMEA







 DOMEA è una tenda a bracci estensibili con cassonetto a scomparsa totale su supporti laterali fissi con contropiastra di ancoraggio, bracci a doppio cavetto inguainato o a catena inox. Il cassonetto viene fornito in tre profili separati. I supporti consentono di installare la tenda sia a parete che a soffitto e, oltre alla vite di microregolazione che consente un corretto accoppiamento dei profili, dispongono anche di un nuovo sistema di inclinazione della tenda con vite passante.

 DOMEA is a fully cassetted folding arm awning on two side brackets and wall accroaching brackets with either a sheathed double cable or stainless steel chain arms. The cassette is supplied in three different profiles. The brackets allow for either a wall or a ceiling installation and, besides the microregulation screw which ensures a perfect profile match, they are also equiped with a new inclination system that uses passthrough screws.

 DOMEA est un store coffre integral qui est fixé sur deux supports latéraux avec une contre-plaques de fixage, bras à doubles cables gainés ou chaîne en inox. Le coffre est fourni en trois profils séparés. Les supports peuvent être montés au mur ou au plafond et le nouveau système d'inclination du store, par vis passante et de microrégulation, assiste le couplage des profils à la perfection.

 DOMEA ist eine Kassettenmarkise auf festen Seitenkonsolen mit Befestigungsplatte und umhülltem Doppelseil – oder rostfreiem Kettenarm. Die Kassette wird in drei getrennten Profilen geliefert. Dank der Konsolen ist sowohl die Wand-, als auch die Deckenmontage möglich. Zusätzlich weisen sie ein neues Neigungssystem mit Stehbolzen auf, und die Mikrostellschraube ermöglicht eine korrekte Verbindung der Profile.

 DOMEA es un cofre de brazos extensibles sobre soportes laterales fijas con contraplaca de anclaje, brazos con doble cable enfundado o cadena inoxidable. El cofre se suministra en tres perfiles separados. Los soportes permiten instalar el toldo tanto a pared como en el techo, y, además de los tornillos de microregulación que permiten un acoplamiento perfecto de los perfiles, disponen también de un nuevo sistema de inclinación del toldo con tornillos pasantes.

# SCHEMA TECNICA

## technical sheet

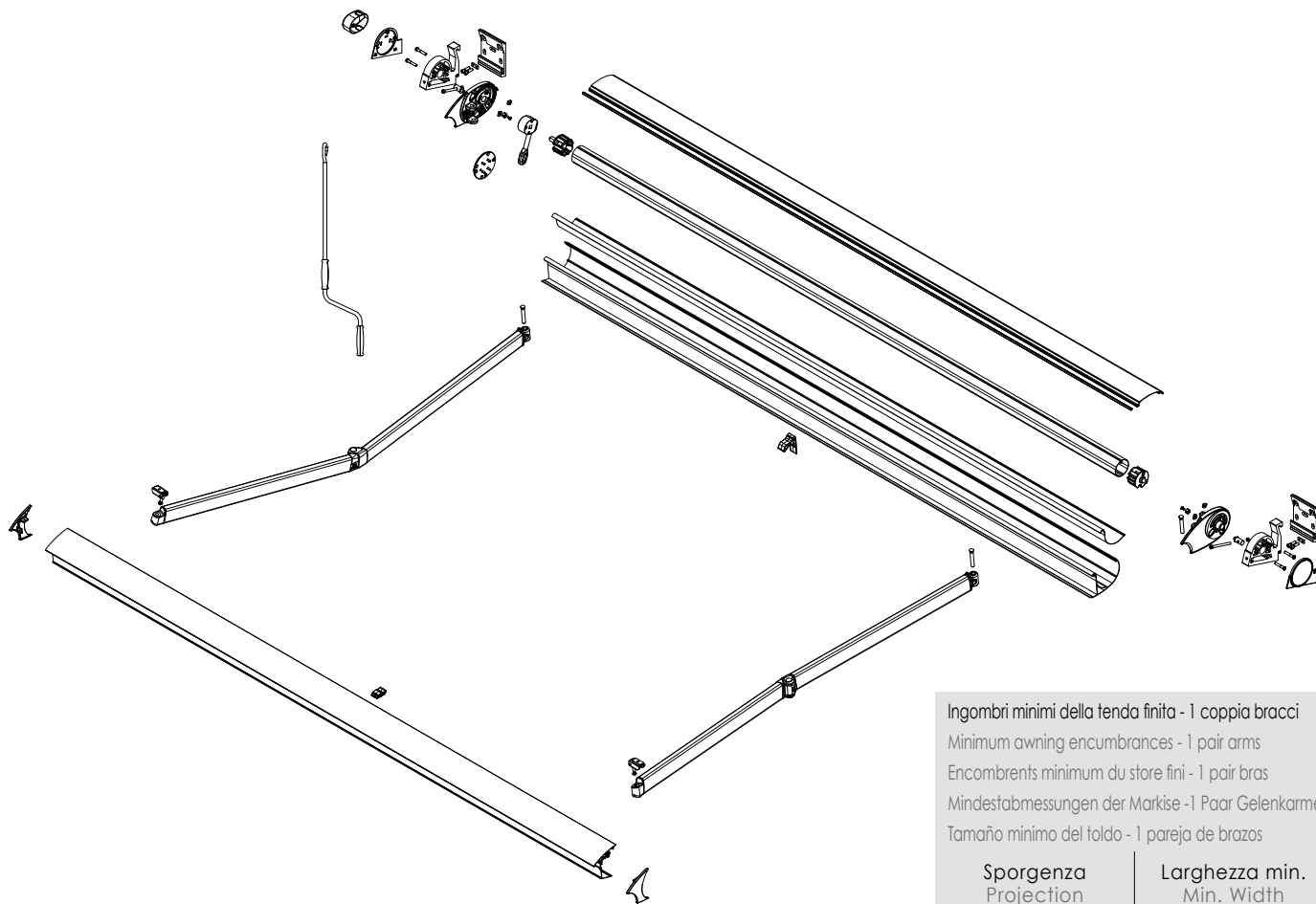

Ingombri minimi della tenda finita - 1 coppia bracci  
Minimum awning encumbrances - 1 pair arms  
Encombrents minimum du store fini - 1 pair bras  
Mindestabmessungen der Markise - 1 Paar Gelenkarme  
Tamaño mínimo del toldo - 1 pareja de brazos

Sporgenza Projection Avancée Ausladung Salida	Larghezza min. Min. Width Largeur min. Breite min. Línea mín.
185	246
210	271
235	296
260	321
285	346
310	371
335	396
360	421



Diagramma di copertura a parete/soffitto - Wall/Ceiling covering diagram



Montaggio a parete  
Wall installation

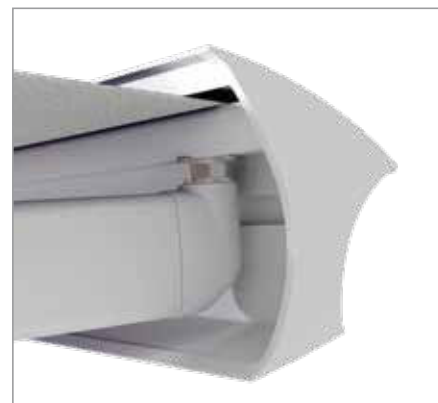
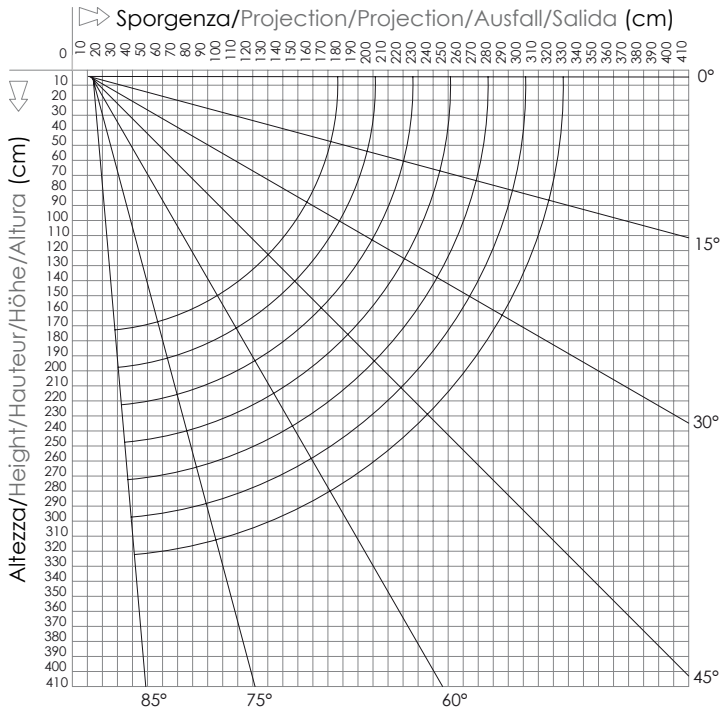
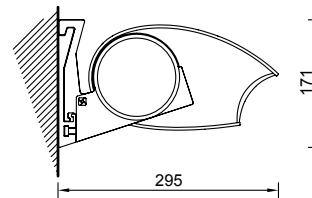

Montaggio a parete 85°  
Wall installation 85°

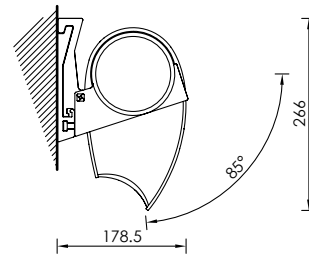

Montaggio a soffitto  
Ceiling installation

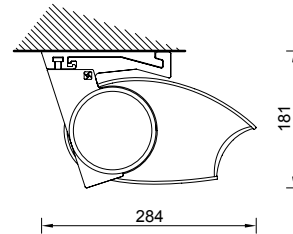

Montaggio a soffitto 85°  
Ceiling installation 85°

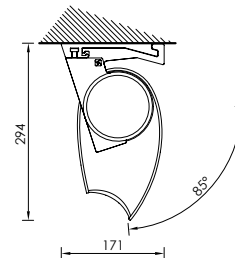

Tutte le misure dei montaggi sono espresse in mm \ All the sizes are in mm \ Tout dimension en mm \ Alle Massen in den Montagenschemen verstehen sich in mm \ Todas las dimensiones están en mm accesorios



awning the Italian way

**BAT S.p.A.**

Via H. Ford - Z.I. Est  
30020 Noventa di Piave (VE) - Italy  
T. +39 0421 65672  
F. +39 0421 659007  
[www.batgroup.com](http://www.batgroup.com) - [info@batgroup.com](mailto:info@batgroup.com)

**BAT FRANCE**

Quartier des 4 Chemins  
Zac Ducournau  
83340 Flassans Sur Issole  
Tel 04 94 78 17 73  
Fax 04 94 04 79 32  
[www.batgroup.com](http://www.batgroup.com) - [batfrance@batgroup.com](mailto:batfrance@batgroup.com)

**BAT IBÉRICA, S.L.**

Travesía Cuenca-3, núm.2  
Pol. Ind. Camporosso  
Apartado de Correos nº 22  
02520 Chinchilla de Monte Aragón (Albacete)  
T. +34 967 261 779 - F. +34 967 261 584  
[www.batgroup.com](http://www.batgroup.com) - [info@batiberica.es](mailto:info@batiberica.es)

**BAT USA CORP.**

Head offices  
445 Bellvale Road  
Chester, NY 10918  
Phone 845 610 1139  
Fax 845 610 1120  
[www.batgroup.com](http://www.batgroup.com) - [batusa@batgroup.com](mailto:batusa@batgroup.com)